

POWER ACOUSTIK

PT-120CM

12.1" Universal Ceiling Mount Monitor

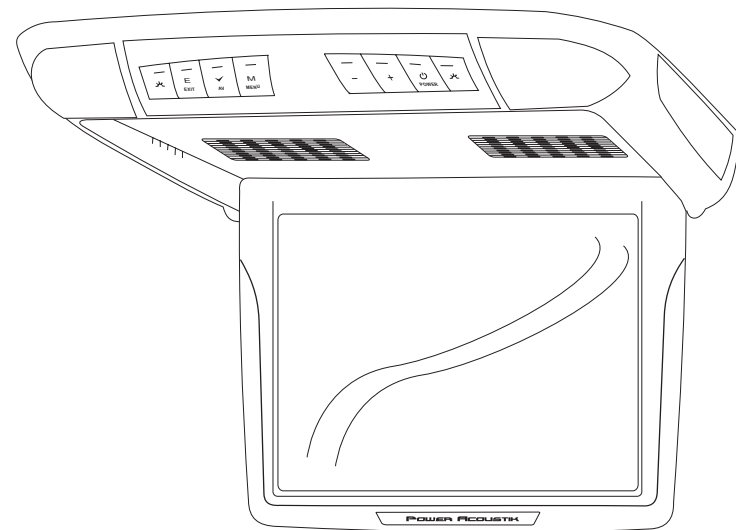

OWNER'S MANUAL



Please read this User's Manual in detail and use the set properly.

CAUTION	3
INSTALLATION	5
NAME AND FUNCTION OF EACH PART	6
Unit	6
Remote Control	7
PICTURE CONTROL	8
CONNECTIONS	9
HOW TO OPERATION THE MONITOR	10
Releasing The Monitor	10
How To Watch Monitor	10
SPECIFICATIONS	11

CAUTION

Please read and observe all warnings and instructions in this owner's manual and those marked on the unit. Retain this booklet for future reference.

There are two kinds of alarm symbols as follows:



WARNING

The lightning flash with arrowhead symbol within an equilateral triangle is intended to alert the user to the presence of "dangerous voltage" within the product's enclosure that may be of sufficient magnitude to constitute a risk of electric shock to people.



CAUTION

The exclamation point within an equilateral triangle is intended to alert the user to the presence of important operating and maintenance (servicing) instructions in the literature accompanying the product.



WARNING



Installation of all TV monitors must be out of the driver's field of sight.



Do not mount the product where it will obstruct the deployment of the airbag or in an area where it would affect the vehicular control. Also be careful to avoid mounting the product where it can become hazardous during sudden stops or in the event of an accident.



Do not try and service these products yourself. Seek only a qualified service center or factory service center.



Use extra caution with any liquids in your car. If you or your child spills any liquid on these products, pull your vehicle to the roadside and turn the key off to disconnect or wipe the products with a towel. Do not operate the equipment until all liquids have either evaporated or you have had the monitor inspected at a service center by a qualified technician. Severe harm or danger can occur.



Be careful not to drop or apply under pressure to the front panel of your video monitor. If the screen cracks due to misuse, your warranty will be void!



Use only a damp cloth to clean the screen and use only purified water on the cloth. Wring out all excess water prior to wiping the screen. Do not use any cleaners or chemicals to clean the screen. In most cases a dry cloth will do!

Power Requirements	DC 12V
Power Consumption	9W
Screen Size	12.1" TFT-LCD
Screen Format	4:3
Resolution Pixel	2400x600
A/V Inputs	2 A/V RCA Inputs
Dimensions(With shroud)	15.1(L)X13.9(W)X3.5(H)inches
Dimensions(Without shroud)	14.8(L)X13.6(W)X2.5(H)inches
IR Power Requirements	DC 12V
IR Power Consumption	3W
IR Transmitter Frequency	Right 2.8MHz Left 2.3MHz
LCD Panel Type	Active Matrix TFT
Compatible video standard	NTSC/PAL Auto Select

Note : This equipment has been tested and found to comply with the limits for a Class A digital device, pursuant to part 15 of the FCC Rules. These limits are designed to provide reasonable protection against harmful interference when the equipment is operated in a commercial environment.

This equipment generates, uses, and can radiate radio frequency energy and, if not installed and used in accordance with the instruction manual, may cause harmful interference to radio communications. Operation of this equipment in a residential area is likely to cause harmful interference in which case the user will be required to correct the interference at his own expense.

CAUTION



Quality installations are best performed by qualified and certified installers.



Watching the monitor for an extended period of time with the engine turned off may deplete the vehicle's battery.



Don't touch the unit if there is a flash of lightning. It may receive an electric shock.



This product is designed for operation with a 12 Volt DC, negative ground vehicle. It is not suitable for operation under other conditions or voltages.



Do not cover heater ducts or vents. This may cause a fire or an electric shock.

Check Point

1. The operating temperature of this product is limited to 14°F~140°F (-10°C~60°C).
Your vehicle can reach temperatures up to 100 C in the summertime.
2. When your vehicle is extremely hot or cold you must allow time for your air conditioner or heater to cool or heat the vehicle and for operating temperatures to return to normal operating ranges. Your monitor will return to its normal functions when these operating ranges are achieved.
3. Optimum picture quality is achieved when you are directly in front of the monitor (+/-45 degrees).
4. If the buttons get stuck, please try to press the up of buttons, it will get back. It won't impact using normal.
5. If you can't find the files name in list when playing, please reset units or turn off/on over again.
6. If the unit can't be change mode when playing some special files which the unit didn't support, please reset units or turn off/on over again.

1. Open the package and check that these items are presents.

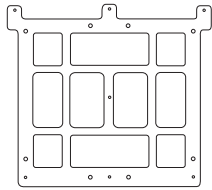

INSTALLATION PLATE

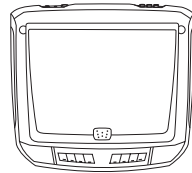

UNIT

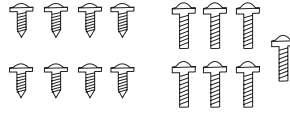

SCREW A

SCREW B

2. Connect the external components to the RCA cable or AV output.
(Refer to the connection diagram on page 9)

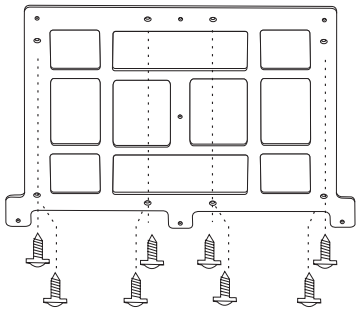

3. Match the position of installation bracket and installation plate with screw A.

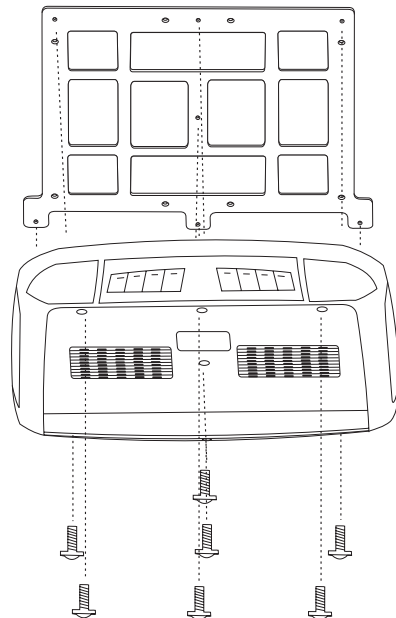

4. Tighten the unit with the supplied screw B.

Releasing the Monitor

Push the open button (located on the front edge of the screen housing) and lower the monitor to the desired angle. You can also adjust the swivel angle.

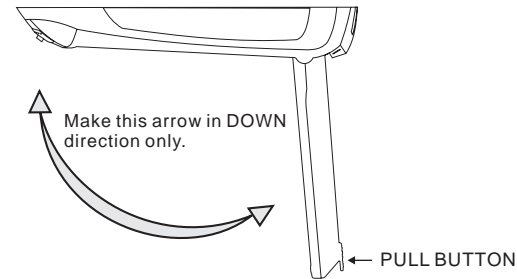

How to watch the monitor

1. Connect the monitor to the external devices.
2. Press the POWER button on either the remote control or the unit once to turn the power on.
Press the same POWER button to turn the power off.

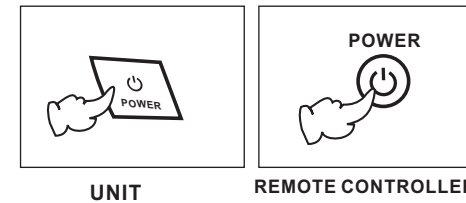

3. Turn on the external devices and view.

CONNECTIONS

On a towel or soft cloth, gently place the monitor assembly “face down” on a stable work surface.

Using the wires provided, complete the audio, video and power connections in your vehicle as shown in the diagram below.

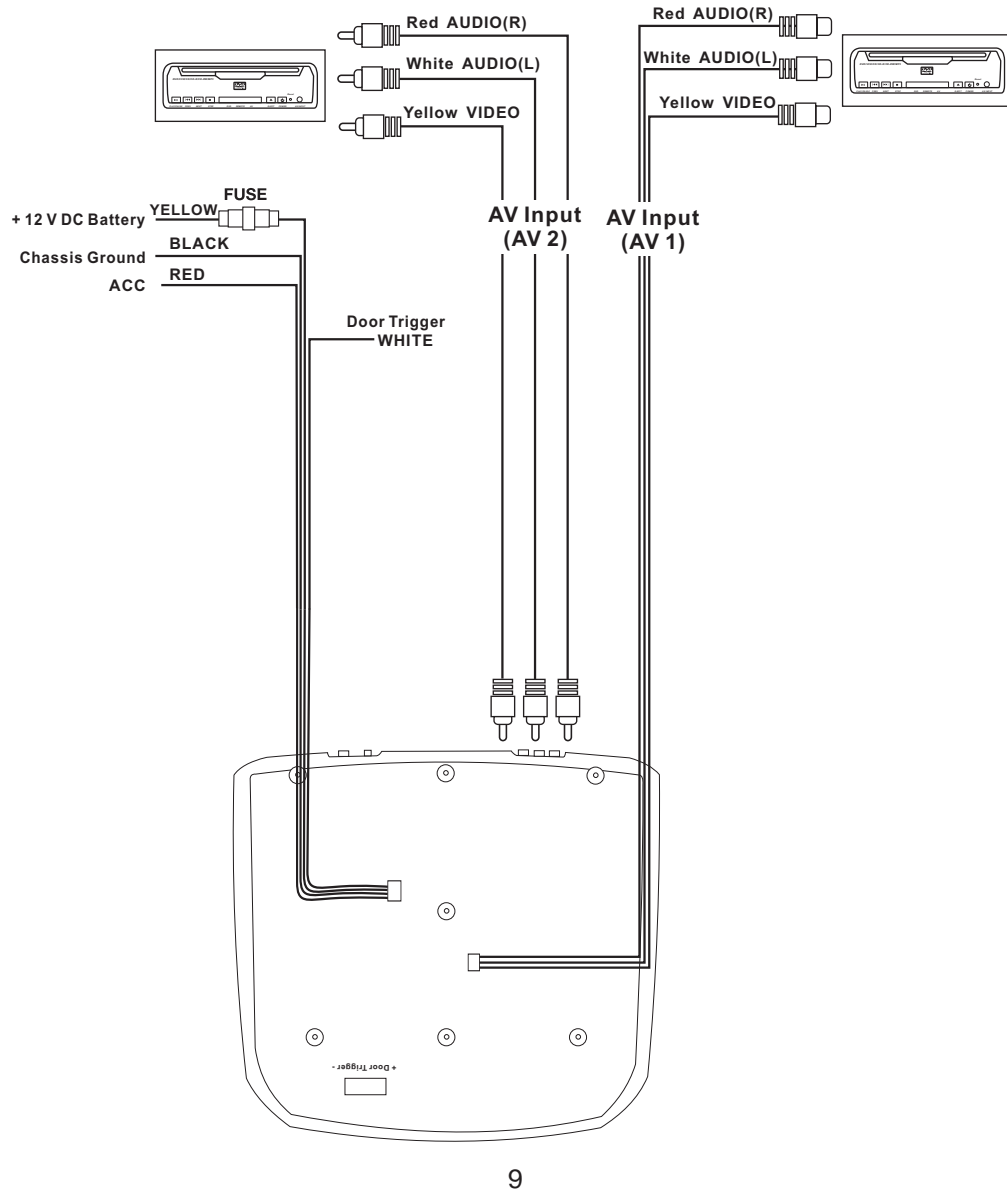

NAME AND FUNCTION OF EACH PART

● Unit

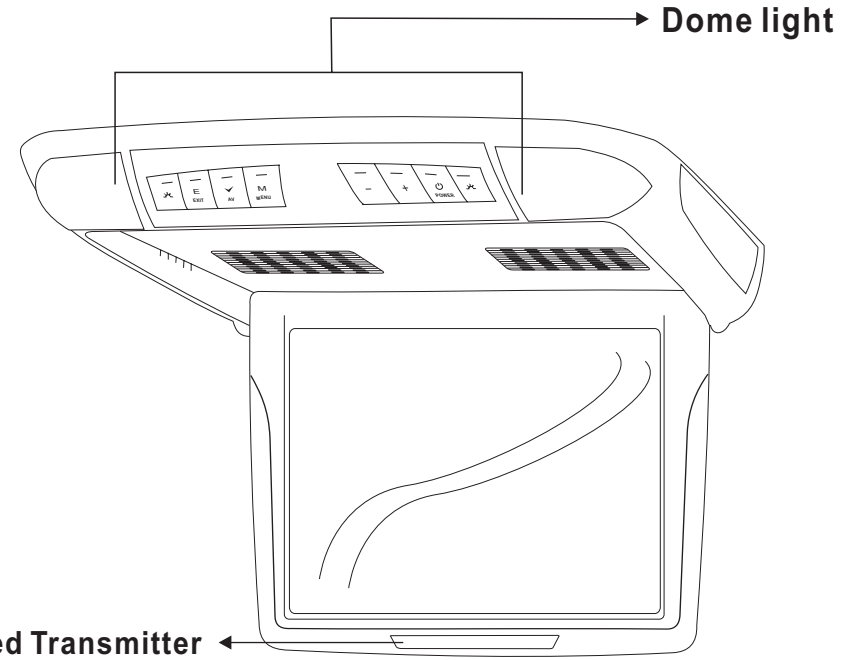

Monitor (Front)

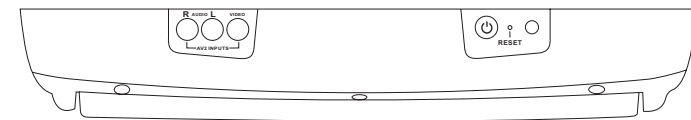

Monitor (Rear)

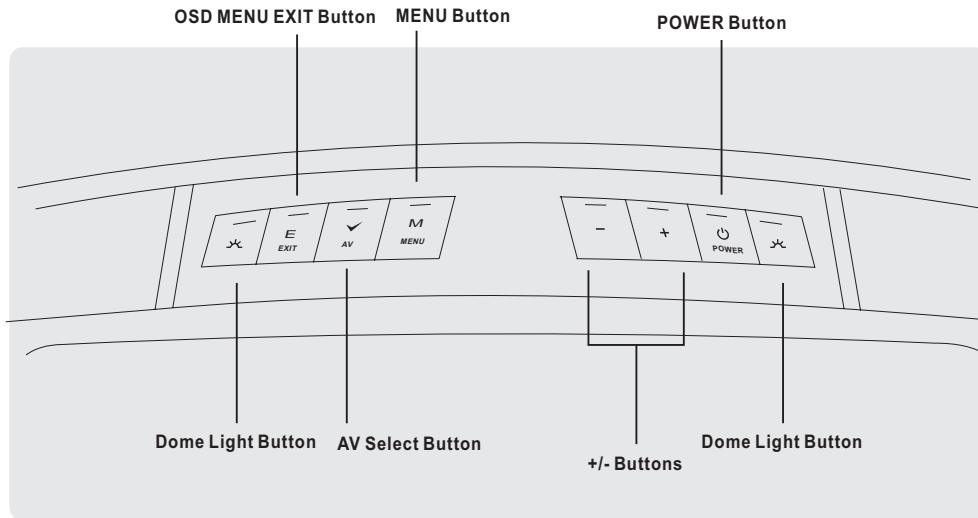

Interface Switch Function

Power: Power ON/OFF

AV: Signal Select

Menu: Press this button for OSD menu.
And select menu option

+: Increase current option value.

-: Decrease current option value.

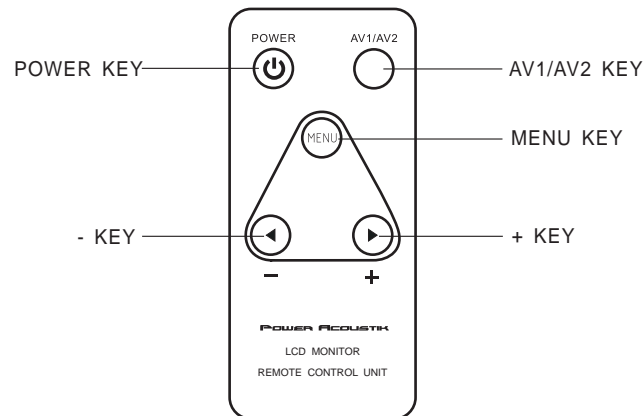

Contrast/Brightness/Color

To adjust CONTRAST, BRIGHTNESS, COLOR press the MENU button until you arrive at the screen for that item. Use the arrow buttons to adjust the value. Press the MENU button to make another adjustment or leave the MENU system.

1. Bring up the on-screen function menu by pressing the MENU button on the unit or the remote control.
2. Press the MENU button on the unit or the remote control of monitor until you see the item you wish to adjust.
3. Use the arrow buttons to adjust the value.
4. Press the MENU button to make another adjustment or leave the MENU system.

CONTRAST



BRIGHTNESS



COLOR



Removing The Snap On Cover(Shroud) From The Housing

Working on a soft surface to avoid damaging the plastic.

Insert the supplied **pry tool** between the **Housing** and **Snap On Cover (Shroud)**, then press the **pry tool** to release the **Snap On Cover (Shroud)**.

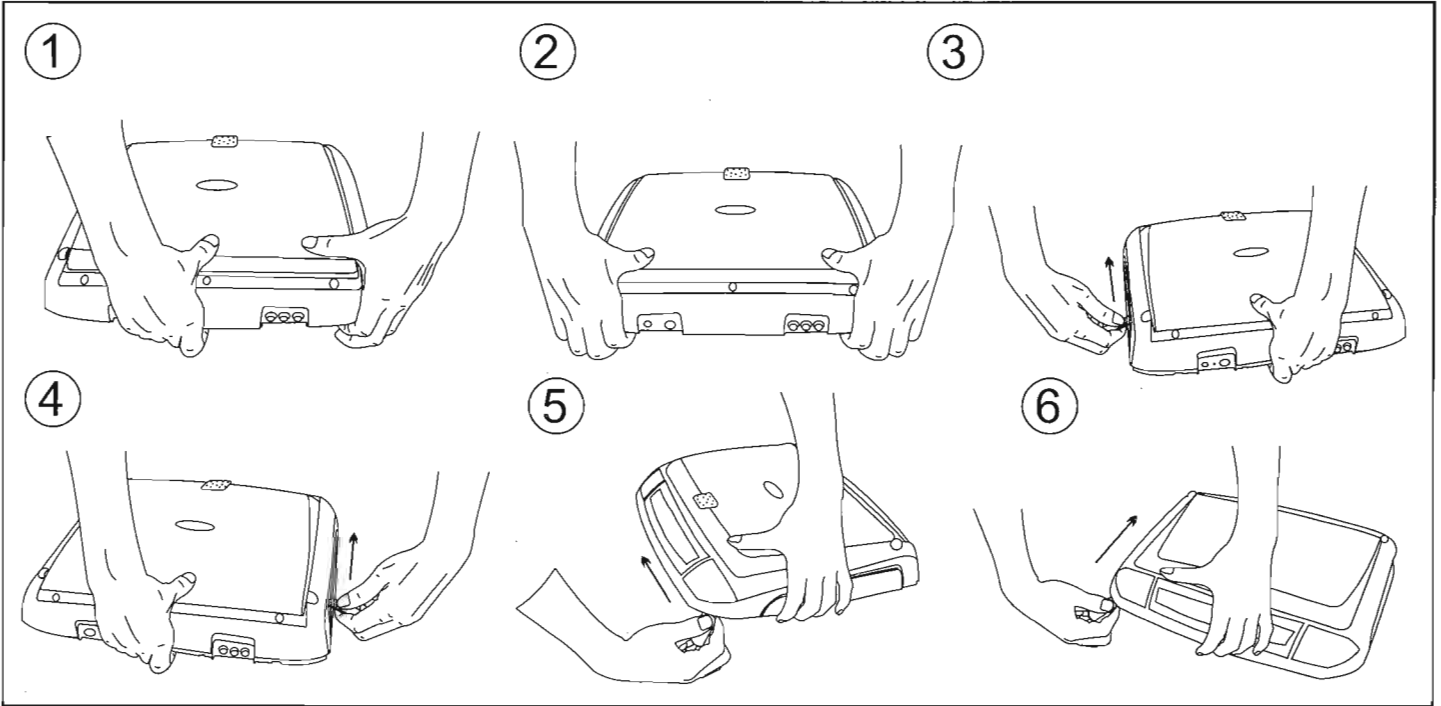

Removing The Snap On Cover(Screen Back) From LCD The Housing

Working on a soft surface to avoid damaging the plastic.

Insert the supplied **pry tool** between the **Housing** and **Snap On Cover (Screen Back)**, then press the **pry tool** to release the **Snap On Cover (Screen Back)**.

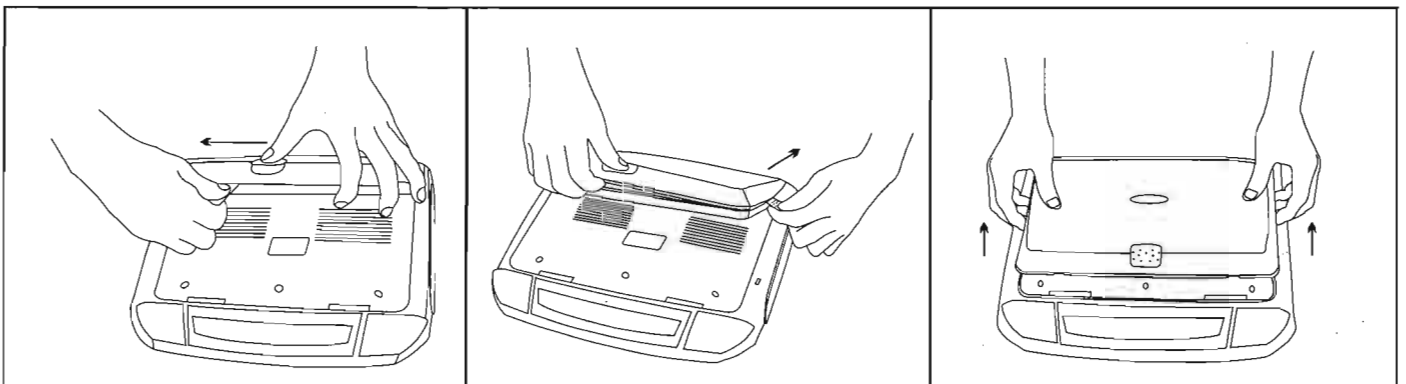

Installing The Snap On Covers

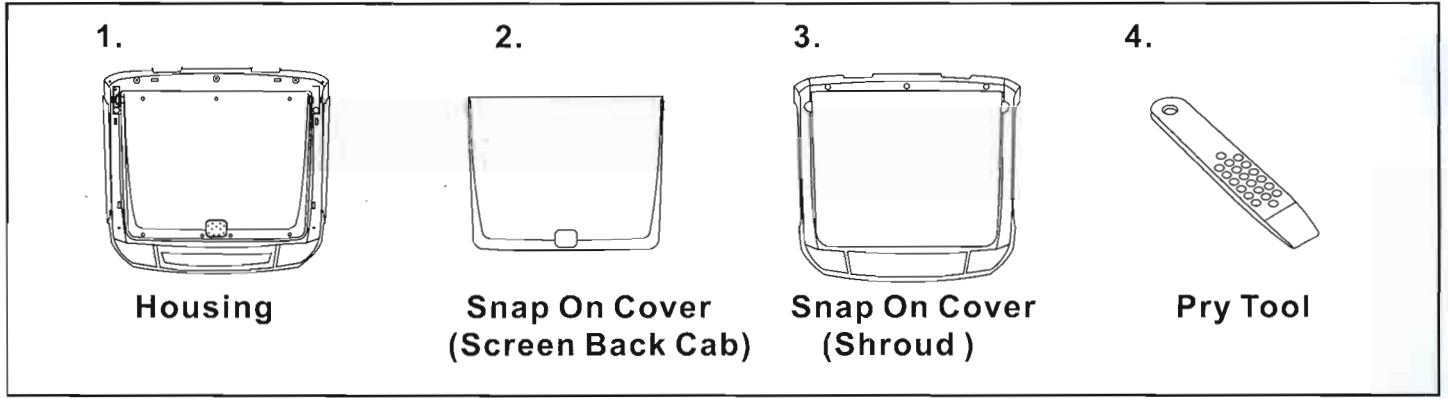

Place the pod on a soft surface to avoid damaging the plastic.

Installing The Shroud

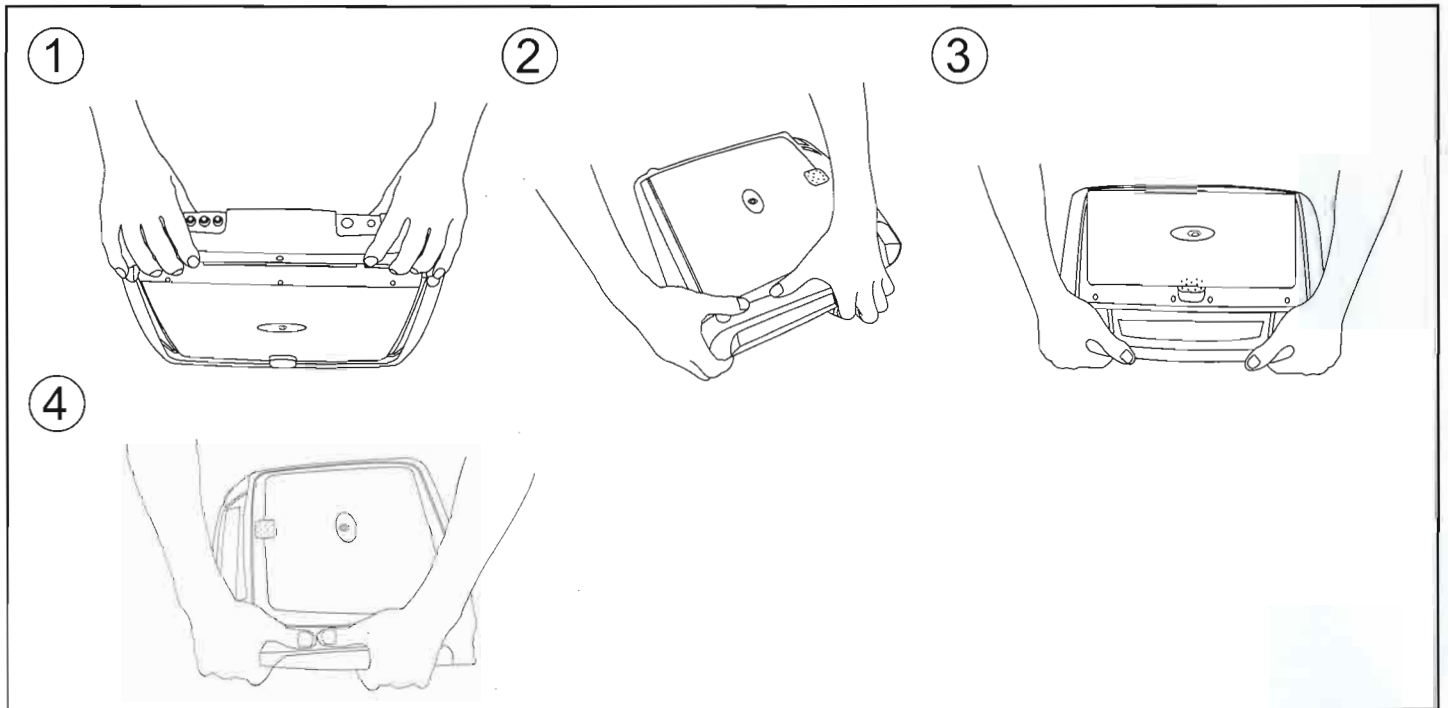

Begin by hooking the area and slide the cover over the pod. The cover will snap in place.

Installing The Screen Cover

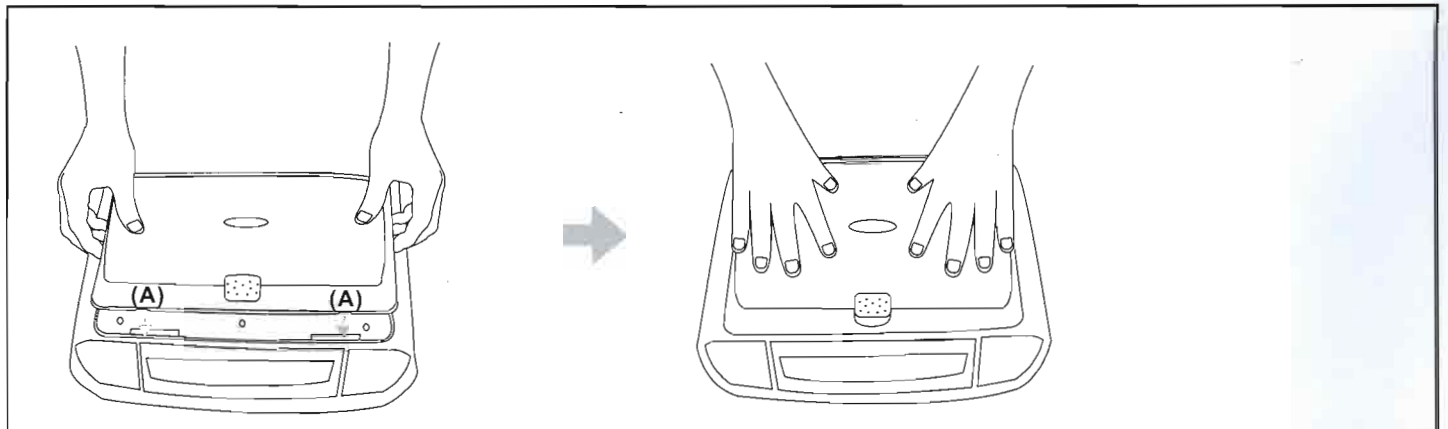

Open the screen and hook the two tabs (A) on the bottom edge of the screen. Snap the opposite side over the hinge.